

50
YEARS
1958-2008

Compton

A reputation built on trust

The **Garage** and **Workshop** collection





Welcome to Compton

Over the last 50 years Compton has built an enviable reputation for manufacturing high quality, long-lasting garages, workshops and sheds. Our product range has continued to grow and we now offer the widest choice of design options in the UK. With more ranges, finishes and optional extras, we offer the versatility and flexibility to ensure that you have a quality building which meets your budget. All built by our professionals to the same exacting standards and meticulous attention to detail, supported by our dedicated service team. We are confident that as you browse through our brochure, you will find the perfect building that will exceed your expectations.

Decide upon the type of building you want by checking through our product range on pages 7 to 23, tailor it to your own personal specification by selecting from our wide range of options on pages 24 to 27, and finally, read up about more practical issues like foundations and planning permission on page 28.

Should you have any questions, we have the largest network of specialist UK agents who are ready and willing to help, advise and manage your order.

As 500,000 happy customers will confirm, we have a long-standing reputation built on trust.

A reputation built on trust.

It might be a new home for your latest car. It might be that long overdue storage area your expanding family demands. Or it might be the heart of your home business.

Whatever your needs, Compton make buildings to last with great care and attention to detail. Substantial sheds, quality garages and spacious workshops you can rely upon. With over 50 years of experience and 500,000 delighted customers over the years, we know how to build long-term quality with flexibility of design thrown in. Whatever kind of building you desire, talk to us. Whether to protect your beloved Austin Healey or to set up your very own home gym.

Let Compton give you a garage, shed or workshop you can trust.



"Thank you for the Structural Guarantee received today. I would like to take this opportunity to say thanks to all of your team and my agent. Once again thanks to you all."

J Rowlands - Mid Glamorgan

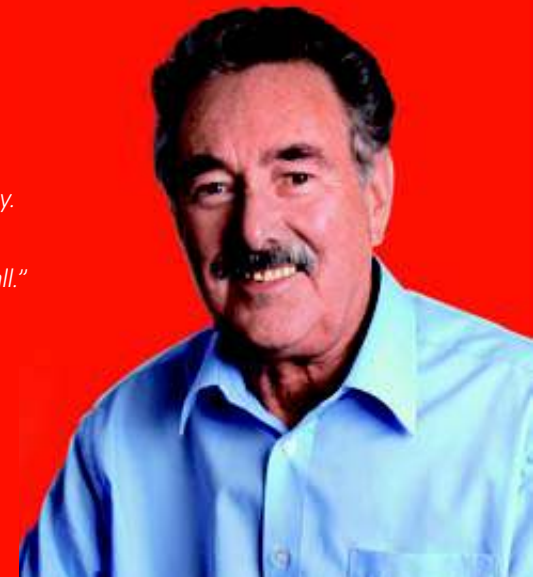

Trust us for value.

Our philosophy is to give you more for less. Our unique combination of build quality, a real understanding of customer needs and the most attentive service means the price you pay for a Compton solution is the best value around. Working on the basis that our customers want long-term quality, we ensure you pay less for the high standards we've built our reputation upon.



Trust us for choice.

Quality obviously comes as standard. Just about everything else is flexible to allow you to design the right solution for your individual needs. With more ranges, more finishes and more optional extras, you can have the garage, shed or workshop your needs and budget demands.



Trust us for quality.

We've established our position as Europe's largest pre-cast concrete garage manufacturer by giving customers the highest standards in product quality. As evidence of this, Compton is registered to the independent ISO9001 quality standard.



Trust us for peace of mind.

Our buildings are designed to offer lasting satisfaction. That's why we confidently offer every customer our 10 year no-nonsense structural guarantee. So you gain peace of mind when buying. And peace of mind long into the future.



Trust us for service.

More than half of our new customers choose us because their friends or family provide a glowing recommendation. We understand that a delighted customer is our greatest asset. So, working closely with our local agents, we work hard to ensure that you receive the best service from the start of the project to the finish. And after.



Trust us for commitment.

Customers tell us that it's our complete offering that really makes us different. Superior quality, attentive service, flexible designs and unrivalled value all play a part, but it's our commitment to go that extra mile that makes us stand out. It's an unbeatable formula that means you can trust us to keep delivering.



Compton Buildings are the best on the market.

They are designed and manufactured in our factory in Warwickshire to the highest standards in the industry.

We want all customers to be happy with their purchases.

If you are not happy with your new Compton building please tell us. We will then do whatever is necessary to resolve any problem or difficulty you may have.

This promise has no exclusions and no small print. It is in addition to your statutory rights.





Premier Brick

Premier Brick gives you the classic beauty of brick but without the cost. It really does look like the real thing. All you miss is the hassle, mess and long timescales for building that are all too common with expensive brick garages.

It's Compton's innovative design that makes Premier Brick look so authentic. You simply won't see panel joint marks. Years of research and development backed by intensive testing ensures it stands up to the closest scrutiny.

You can choose between two sculptured brick finishes - either red or buff. Standing at 7ft to the eaves, it's ideal for taller vehicles or people who want that feeling of spaciousness. Adding to the prestigious feel are coloured fibre cement roof sheets that come as standard with either brown, terracotta, green or grey options.

Prior to installation a survey will be conducted by a Compton expert and a free maintenance check will occur approximately 12 months later.

It's simple to choose a Premier Brick to suit you. Select your building and roof colour then choose one of four style packages: Cedar, White PVCu, Golden Oak Woodgrain or Rosewood Woodgrain.



Opposite: Premier Brick Red Brick 2.74m (9' 0") wide Cedar package with Terracotta Roof sheets. Above: Premier Brick (Buff finish) 3.05m (10'0") wide with Rosewood wood grain package

State-of-the-art design.

Range

12.5°
pitched
roof

High

Single

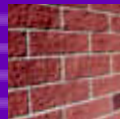

Brick Red



Brick Buff
(See page 19)



Personalise your Compton Building.

At Compton, we understand that all of our customers have different needs and we therefore have the most comprehensive range of options available. Just about everything is flexible, enabling you to choose from an extensive range of doors, fascias, roof sheets and front posts through to storage solutions and security options. You can personalise the design of your garage, shed or workshop giving you the right solution to suit your requirements and your environment.

A greater choice of doors.

Open your mind to our extensive selection of doors. Whether you want electronically operated luxury or just a specific finish, you can now simply pick and choose. And as you would expect from Compton, all doors are sourced from a leading manufacturer, so you know you'll get lasting quality.

Every garage comes with our standard door that's pre-finished with white polyester powder coat primer and is ready to take the colour of your choice. Or for a more indulgent touch, choose Cedar, Georgian or one of the increasingly popular woodgrain finishes.

We also offer the right option for different types of usage. You can specify an offset door on larger garages. You might require throughway doors - an up-and-over door in the rear wall allowing through access for items like boats.

Side or rear access through any of 7 styles of personnel door is easy to accommodate. What's more, these galvanised steel doors have 3-point locking with 10,000 different key combinations for increased security.

Up-and-over doors come with a 10-year warranty covering safe and reliable operation (provided they receive regular and recommended maintenance).

Plastisol finish up-and-over doors are guaranteed for corrosion resistance for 10 years.

Doors



White primed horizontal rib

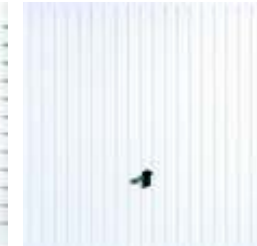

White plastisol vertical ribbed



Georgian



Cedar

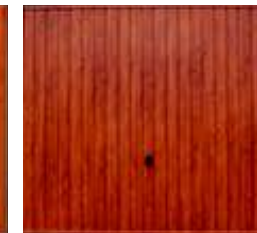

Wood grain - Golden Oak



Wood grain - Rosewood

Personnel doors



4ft primed



Primed



Plastisol



Georgian



PVCu



Golden Oak



Rosewood



Cedar

Throughway doors



Offset doors



Electrically operated doors



Thermaglide roller shutter

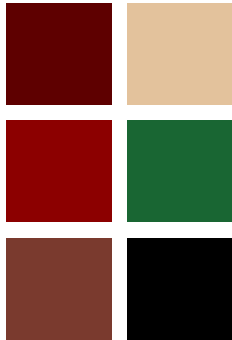

Compton Auto-lift

Auto-lift remote garage door opener is suitable for all our up-and-over doors. Complete with remote control and timed courtesy light to allow you to step out of the car into an illuminated garage. This quiet, reliable and low-maintenance design means you'll never need to brave the elements again when opening your garage door.



A window of opportunity.

Light can make the world of difference. So we offer the widest range of timber or PVCu windows in all varieties of styles and sizes. Our timber windows are preservative treated and pre-glazed. And any opening casements are rust resistant with galvanised storm proof hinges and brown enamelled casement stays. Our many PVCu double-glazed options are all designed to standards set by 'Secured by Design' - the government sponsored initiative to ensure strict security criteria. Shown here in white, these windows are also available in rosewood and golden oak finishes. Opening windows come complete with friction hinges and lockable handles.



Timber Windows

1.22m (4'0") wide

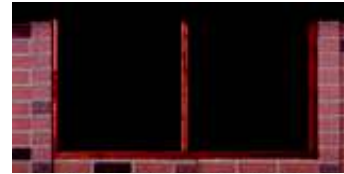

D-fixed



B-opening

0.61m (2'0") wide



T-fixed



S-opening

PVCu Windows

1.22m (4'0") wide



K-fixed



U-opening

0.61m (2'0") wide



Y-fixed



W-opening

Alternative window options are available on Apex Rockstone - talk to your local agent for details

Complete the look.

We understand that you'll want your garage, shed or workshop to complement your home or garden. So we give you more flexibility with colour, style and accessory options. From roof sheets to front posts or fascias, you can personalise it your own way.

With two brick front post designs, you can add a little extra style to the face of your garage that's most visible. The real brick is available in four finishes (see below) to suit most designs while the brick effect is available in all widths and heights for every Compton garage.

Brick front posts



Real brick posts



Brick effect posts

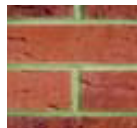

Autumn red



Southern Stock



Warwick Red



Reclaimed

Fascia options



Cedar fascia



Rosewood fascia



White UPVC fascia



Golden Oak fascia



Plastic fascia

Cedar is an option on Apex garages, with PVCu, Golden Oak or Rosewood fascias suitable for both Apex and Banbury garages. White maintenance free plastisol is available for flat garages.

There are four colours of painted roof sheets. And six variations of granular steel roof tiles. Have natural light pouring in from above with translucent roof sheets available on Apex garages.

Painted roof sheets



Terracotta



Brown

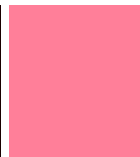

Terracotta



Green



Grey

Granular steel roof tiles



Bronze



Terracotta

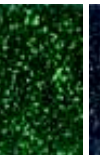

Green



Charcoal

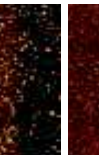

Brindle



Red

Translucent roof sheets



Smarter storage.

To preserve the structural integrity of the pre-cast concrete (and your 10 year guarantee) drilling for shelving should be avoided. But thanks to our alternative options, you can still store a wide range of household items. The Shelf Stack is a six shelf unit that's screwed into brackets welded into the steel uprights and is delivered along with your building. Our 3-shelf pack is for any garage design and comes with brackets that are fitted using existing panel bolts. You can also order Garage Grids, a highly versatile system of hooks, brackets and baskets that you can arrange as you like.

Garage Grids



Shelf stack

Lining your garage.

Lining clips are supplied in a pack of twelve galvanised steel clips, screws and washers that enable timber bearers to be fixed vertically to line all or part of a building (minimum bearer depth 32mm (1¼"), batten supplied by others).

For further advice on lining your building please contact your local agent.

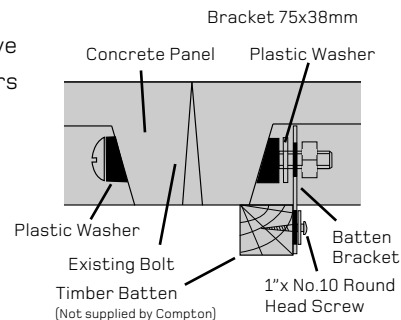

Security options.

Compton garages have been designed with security in mind. The robust nature of their design and build quality ensures they offer strong protection against the threat of theft or vandalism. However there are further options available to increase security as follows:

Windows

Drawing upon technology developed by Secured by Design, our double-glazed PVCu window range offers greater security than ordinary windows. You can further protect your goods with exclusive laminated glass. The tough outer pane is almost impossible to break giving you extra peace of mind.



Doors

Compton has introduced four point secure locking on our up-and-over doors to give double the protection compared to standard doors. A key-operated secure handle makes it virtually impossible to break the lock on the door. It also has 10,000 different key combinations; a benefit also found on our 3-point locking steel personnel doors.



Roofing

Our plastisol galvanised steel roof sheets (which also have an anti-condensation treatment) will deter even the most ardent burglar. The sheets are fixed to our roof purlins with special high security fixings, requiring a specialised tool to remove them. So the casual thief would simply be wasting their time.



Preparing your garage base – do's and don'ts.

Compton builds for the long term. Therefore, it is wise to ensure your foundations are also designed for the long term, too. If in doubt, talk to your local Compton agent who will be able to give straightforward advice. In the meantime, here are a few tips to consider.

- ✓ Do use a local agent recommended service or a competent local builder.
- ✓ Do make sure your base is flat, square and level.
- ✓ Do build your base 152mm (6") wider and longer than the external dimensions of your building.
- ✓ Do ensure that the base stands proud of the surrounding ground so that water will not run on to the base.
- ✓ Do consider the type of soil (clay needs a different base design to sandy loam soil), and look at the proximity of trees, hedges and roots.

Consider if you need approval.

Very few of the buildings in our range need local authority approval (such as Planning Permission or Building Regulation approval). Your local agent will advise, but only a letter from your local council can confirm if you need their permission to proceed. For further details see our Technical Information and Your Questions Answered brochures. If you are in any doubt talk to your local authority.

- ✓ Do consider putting in a damp course if you want to store anything inside your building.
- ✓ Do look up when marking out your base – remember that roof sheets and gutters overhang the wall, particularly important on a boundary.
- ✗ Don't construct your base from tarmac, paving slabs, paving blocks or any other material other than concrete.
- ✗ Don't build your base at a level lower than surrounding ground, or we cannot guarantee the performance of the sand and cement fillet.
- ✗ Don't build your base with a fall to the front – we provide a hardwood timber weather bar free of charge to prevent water and leaves blowing under your up and over door.

"I write to congratulate you and your courteous staff for the cheerful service that we received from everybody connected with your company..... Thank you all, it was a pleasure to do business with you."

Mr & Mrs Furzer

